

drive™

www.drivemedical.com

Aluminum Rehab Shower
Commode Chair



EU Authorized Representative
Drive Medical LTD
Ainley's Industrial Estate
Elland, West Yorkshire,
United Kingdom HX5 9JP

www.drivemedical.com

drive™

Assembly Instructions

1. Remove the frame, backrest set, and headrest from carton
2. Insert the front casters into the frame and use "E" clips to secure them in place.
3. Insert the quick release pins into the middle of the large wheelchair wheels and slide wheels into the sides of the frame. The wheel will lock into place.

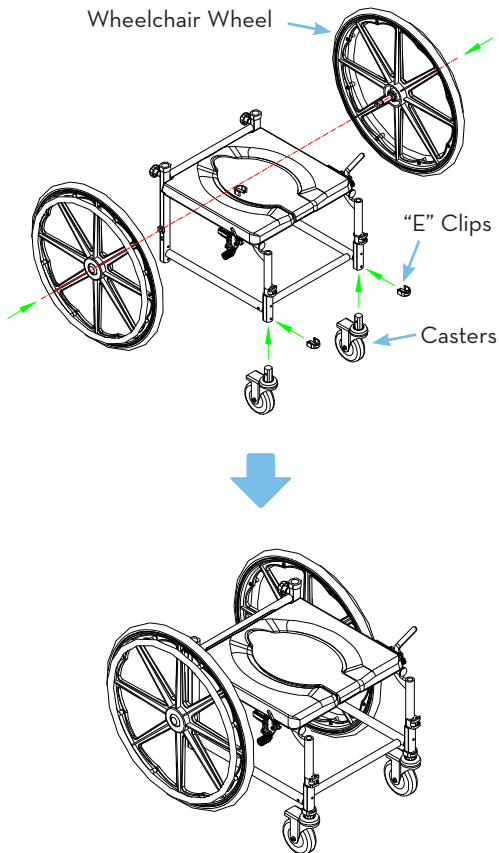

4. Assemble the footrests by inserting the footrests into the top of the front legs from the outside of the frame. Once inserted, turn the footrests inward until they lock in position.

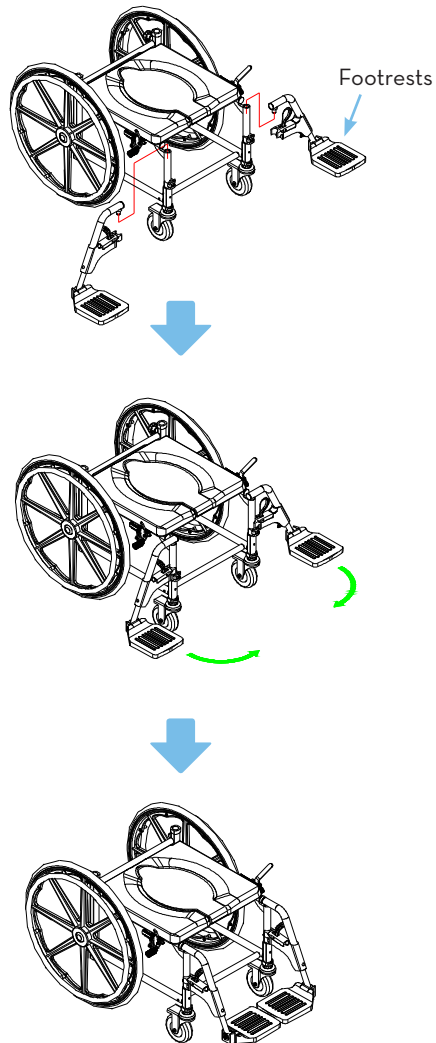

5. Assemble the backrest by inserting the supporting poles into the back of seat frame. Secure in place using the lock knobs provided.

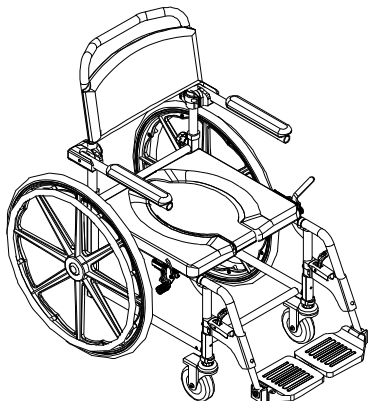
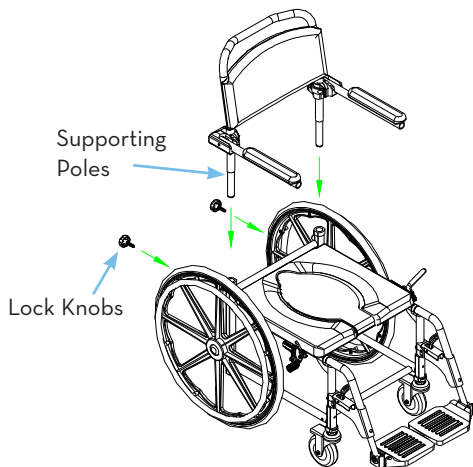

6. The angle of footplate is adjustable to fit the user. Using the allen key, loosen the screws by turning counter-clockwise, adjust the footplate to a suitable angle of footplate and re-tighten.

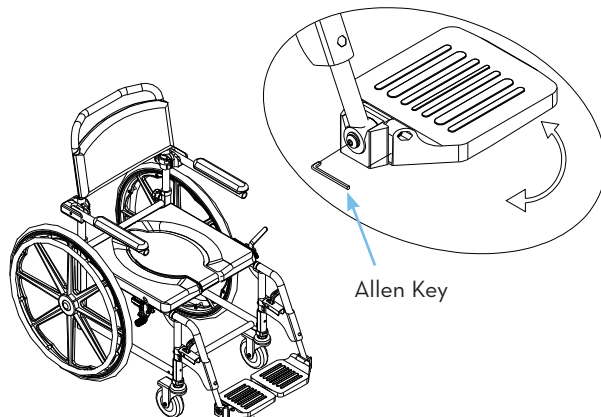

7. Slide commode bucket underneath seat into receptacle.
8. Remove cover over commode bucket before use.

additional precautions

1. Toilet seat must be in down position before use. Failure to do so may result in damage to commode and possible injury.
2. Do NOT install commode without first reading and understanding this assembly and instruction sheet. If you can not understand these instructions, contact a healthcare provider or technical professional before attempting to install.
3. Inspect all parts for shipping damage before assembly. If there is shipping damage - DO NOT USE. Contact provider/carrier for further instructions.
4. Make certain that the “E” Clips protrude through the hole of each leg extension. This will ensure that the leg extensions are securely locked in position.
5. Ensure ALL screws, nuts and/or bolts are tightened.
6. Footrests can be folded up when not in use by folding the footplate upward, releasing the locking mechanism, and folding inward to the front of the chair.
7. Users with limited physical strength should be supervised or assisted while using commode.
8. Use the arm supports only for assistance. DO NOT attempt to use the arms to support full body weight.
9. Arms should be pushed back to assist in transfer onto/off the device.

WEIGHT CAPACITY 250 LBS

lifetime limited warranty

Your Drive Medical product is warranted to be free of defects in materials and workmanship for the lifetime of the original consumer purchaser.

This device was built to exacting standards and carefully inspected prior to shipment. This Lifetime Limited Warranty is an expression of our confidence in the materials and workmanship of our products and our assurance to the consumer of years of dependable service.

This warranty does not cover device failure due to owner misuse or negligence, or normal wear and tear. The warranty does not extend to non-durable components, such as rubber accessories, casters, and grips, which are subject to normal wear and need periodic replacement.

If you have a question about your Drive device or this warranty, please contact an authorized Drive provider.



© 2012 Medical Depot, Inc. All rights reserved.
Drive is a trademark of Medical Depot, Inc.
Port Washington N.Y. 11050 USA Made in China